

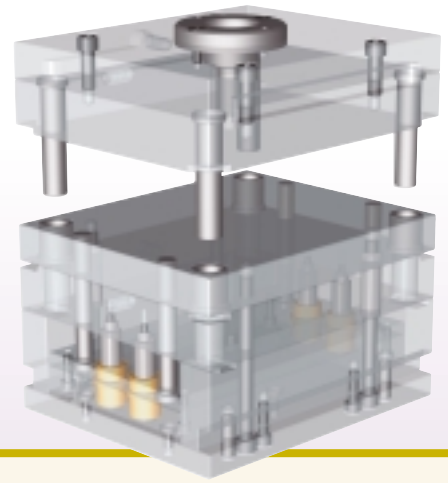

E-Series MOLD BASES



When ordering specify the following:

- Catalog number: **E1215**
- **A** plate thickness
- **B** plate thickness
- **O** sprue bushing orifice
- **R** sprue bushing radius
- Locating ring LR501 or LR504

11⁷/₈ x 15

Example: E-1215-1717 O=7/32 R=1/2

